

# QR X350



## User Handbook

### Specifications:

Main Rotor Diameter: 556mm

Brushless Motor spec: WK-WS-28-008A

Weight: 792g (Battery included)

Main Rotor Blade Length: 206mm

Brushless ESC spec : WST-15A(G/R)

Takeoff Weight: <1200g

Length: 289mm

Receiver: DEVO-RX702

Experience Level: Intermediate

Width: 289mm

Transmitter(option): DEVO-6/7/F7/8S/10/12S

Recommended Environment: Indoor/Outdoor

Height:180mm

Battery(option): 11.1V 2200mAh Lipo

Completion Level: RTF/BNF

### Features:



GPS hold system



One Key Go Home

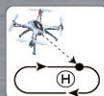

Failsafe to return home & Landing



Altitude Sensor



Stable Mode with GPS and altitude Hold.

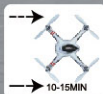

Flight time 10-15 minutes



Adopt anti-vibration camera mount Suit for Gopro(Camera excluded)







Low voltage protection

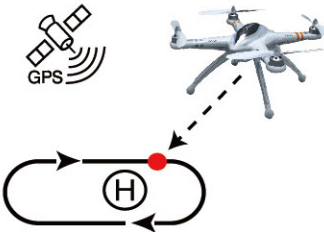

# QR X350

Walking in Era and Towing the Trend

Standard Version: GPS(Altitude Hold)/ One Key Return home/Failsafe Return and landing	FPV Version: Enjoy the First Person View live video transmission feedback on the Radio	EXT function I: Wifi Version Low cost, advanced function, directly control by mobilephone		EXT function II : Adopt anti-vibration camera mount, suit for Gopro (Camera excluded)	
		 <p>WiFi control range above 250 meters</p>		 <p>Suit for Gopro ( Camera excluded )</p>	
		Basic Version	Standard Version	FPV Version	Wifi Version
Main control board		●	●	●	●
GPS Module		●	●	●	●
Compass Module		●	●	●	●
Receiver			●	●	●
DEVO7			●		
DEVO F7				●	
FPV Module ( TX5803/TX5804 )				●	
Camera ( DV04 )				●	
FP Transfer Wire				●	
WiFi Module					●
Camera Mount ( Option )					
Battery ( Option )					
Charger ( Option )					

# Contents

<b>01. Forewords</b> .....	1	<b>08. Basic Flight Instruction</b> .....	5
<b>02. Safety matters needing attention</b> .....	1	8.1 Main Control System Control Mode .....	5
2.1 Important Statement .....	1	8.2 Code binding .....	6
2.2 Safety matters needing attention.....	1	8.3 Motor unlock/lock/ Stop rotating.....	6
(1) Far away from obstacles and people .....	1	8.4 Compass Calibration .....	6
(2) Keep away from humidity.....	1	8.5. Gyro Calibration .....	7
(3) Proper operation and maintenance.....	1	8.6 Accelerometer Calibration .....	7
(4) Avoid flying alone .....	1	<b>09. Advanced function specification</b> .....	7
(5) Safety operation .....	2	9.1 The flowchart of GPS Satellites Signal (Need to connect with GPS module) .....	7
(6) Away from highly spinning parts .....	2	9.2 Failsafe to Return & Landing .....	7
(7) Protect from heat.....	2	9.3 One Key Go Home .....	8
2.3 Attention before flight.....	2	9.4 Position Hold .....	8
<b>03. Definition of Aircraft Orientation</b> .....	3	9.5 Low Voltage Protection .....	8
<b>04. Configure</b> .....	3	<b>10. Transmitter control</b> .....	9
<b>05. Assembly Instruction</b> .....	4	10.1 DEVO-7(optional radio) setting.....	9
5.1 Propellers Installation .....	4	10.2 DEVO-6/F7/8S/10/12S(optional radio)setting .....	10
5.2 Compass & Landing Gear Installation .....	4	<b>11. Instruction and attention of GA005 balance charger</b> .....	11
5.3 Camera mount and camera (option) Installation .....	4	11.1 Parameters of GA005 balance charger .....	11
<b>06. Brushless ESC/Brushless motor/Power board connection</b> .....	4	11.2 Features of GA005 balance charger.....	11
6.1 Brushless ESC and Brushless motor Connection ....	4	11.3 Instruction of GA005 balance charger.....	12
6.2 Brushless ESC and Power board Connection .....	4	11.4 Operation steps .....	12
<b>07. Main control board guideline</b> .....	5	11.5 Charging status corresponding to LED .....	12
7.1 Main control board port Instruction (Refer to the real picture) .....	5	11.6 Matters needing attention .....	12
7.2 Main control board and Brushless ESC Connection Illustration .....	5	11.7 Maintenance of battery pack .....	12
7.3 Main control board and Receiver Illustration .....	5	<b>12 Steps of flight</b> .....	13
7.4 Main Control Board Installation Requirements .....	5	<b>13 Flight over</b> .....	13
		<b>Appendix 1 – Manual flight control</b> .....	14
		<b>Appendix 2 – Trimming the Manual flight actions</b> ....	15



## 01

## Forewords



## 02

## Safety matters needing attention

**Dear customer:**

Thank you for purchasing a Walkera radio control aircraft product. In order to quickly and safely master the operation of the "QR X350", please read the user handbook carefully and then keep it in a safe place for future consultation and reference.

**2.1 Important Statement**

- (1) This product is not a toy. It is a piece of complicated equipment which harmoniously integrates engineering materials, mechanics, electronics, aerodynamic and high frequency radio. Correct installation and adjustment are necessary to avoid accidents taking place. The owner must always operate in a safe manner. Improper operation may result in serious property damage, bodily injury or even death.
- (2) We accept no liability for damage and consequent damage arising from the use of these products, as we have no control over the way they are maintained, used and operated.
- (3) This product is suitable for experienced Aircraft pilots aged 14 years or more. All minors must be accompanied by a responsible adult when flying.
- (4) The flight field should be legally approved by the local government. We accept no liability for any safety duties or fines arising from operation, usage or mis-control after the sale of the products .
- (5) We consign our distributors to offer technical support and service after sale. Please contact the local distributors for problem resolution caused by usage, operation, maintenance, etc.

**2.2 Safety matters needing attention**

Aircraft flight is a high risk hobby, whose flight should be kept far away from other people. Mis-assembled or broken main frame, defective electronic equipment, and/or problematic radio system will lead to unforeseen accidents such as bodily injury or property damage. The pilot **MUST** pay attention to the flight safety and **UNDERSTAND** his responsibility for accidents caused by his carelessness.

- (1) Far away from obstacles and people

An Aircraft in flight has risk of uncertain flight speed and direction which is potentially dangerous. When flying, please keep your Aircraft far away from people, high buildings, high-tension lines, etc, and avoid operating in rain, storms, thunder and lightning.

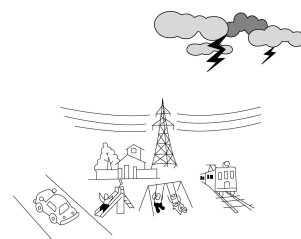

- (2) Keep away from humidity

Aircraft should be kept away from humidity and vapor because its complex, precise electronic components and mechanical parts may be damaged.



- (3) Proper operation and maintenance

Please use Walkera original spare parts to upgrade, modify or maintain your Aircraft in order to ensure its safety. Please operate your Aircraft within the range of functions permitted. It is forbidden to use it outside of the safety laws or regulations.

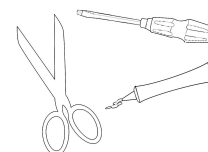

- (4) Avoid flying alone

At the beginning of learning about radio-controlled flight there are some difficulties to overcome. Please avoid flying alone. Invite experienced pilots to guide you (two of the most effective methods to practice are via a PC flight simulator and/or under the supervision of a skilled pilot).

# QR X350

**2.4GHz**

## (5) Safe operation

Please fly your Aircraft according to your physical status and flight skills. Fatigue, listlessness and mis-operation will increase the possibilities of accidental hazard.



## (6) Away from highly spinning parts

Please keep pilot, people and object away from the spinning blades of both main rotor and tail rotor.



## (7) Protect from heat

An Aircraft is made from metal, fiber, plastic and electronic components, etc. Please keep away from heat and sunshine in order to avoid distortion, even damage, caused by high temperatures.

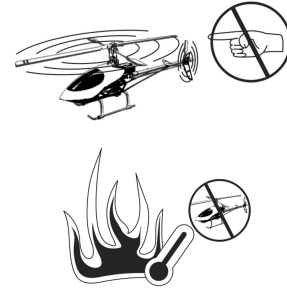

## 2.3 Attention before flight

- (1) Ensure the battery packs of both transmitter and receiver are fully charged (saturated).
- (2) Ensure both the throttle stick and the throttle trim of your transmitter stay at the lowest positions before operation.
- (3) Please strictly obey the order of turn-on and turn-off before operation. When starting your flight, please turn on your transmitter first, and connect the power cable of your Aircraft last.  
When finishing your flight, please disconnect the power cable of your Aircraft first, and turn off your transmitter last.
- (4) An upset in the order of connection may cause your Aircraft to loose control. Please cultivate a correct habit of turn-on and turn-off.



# 02

**Safety matters needing attention**

We define the orientation of Aircraft in order not to cause confusion in the following descriptions. That is to say, the tail boom of Aircraft is facing the pilot (tail in), and its head facing forward (front of pilot). The left hand of pilot is the left side of Aircraft, the right hand of pilot is the right side of Aircraft Its head is to the front and its tail boom is to the back. The direction in which main body of Aircraft is facing is up, and its skids are facing down.

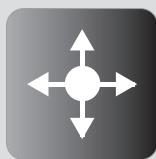
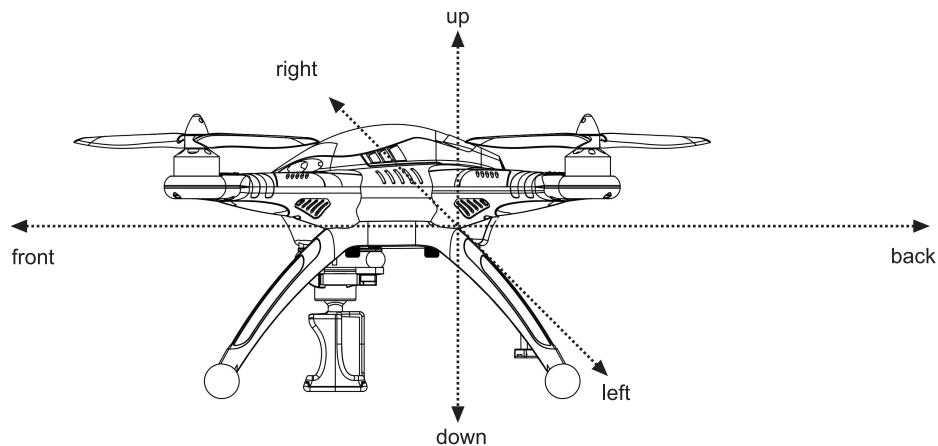

## 03

### Definition of Aircraft Orientation



## 04

### Configure



▲ QR X350



▲ Transmitter (Option)



▲ Li-polymer battery pack(Optional)



▲ GA005 balance charger(Optional)



▲ Power adapter(Optional)

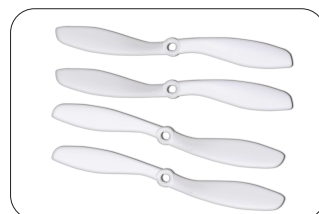

▲ Main rotor blades



▲ User Handbook



▲ Tool kit

# QR X350

2.4GHz

QR X350 is an all-in-one new model, which is specialized design for Walkera fans. All testing has been finished before out of factory, only simply set up is needed before your ready to fly.

## 5.1 Propellers Installation

- (1) Prepare Aircraft and propellers.
- (2) The propeller with spin-mark should be upward installed, make sure the propeller spin-mark and its equipped motor rotating should be direction consistently (the arrow in image is motor rotating direction).
- (3) Tighten the ornament cap (No suggest to use thread glue ).

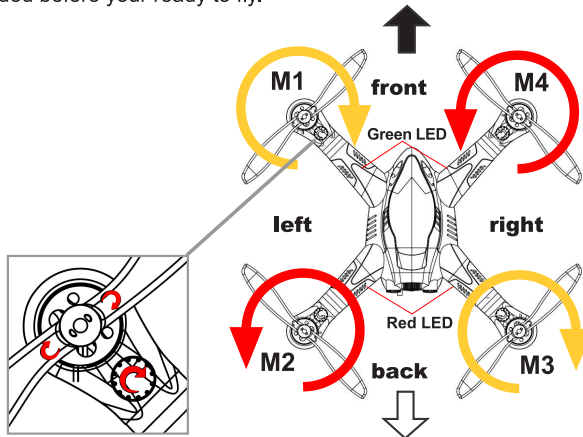

## 5.2 Compass & Landing Gear Installation

Please install landing gear properly, connect and calibrate the compass module.

- (1) Prepare aircraft and landing gear.
- (2) Firstly, install the landing gear with compass on the right side of the aircraft, let ribbon wire go through the landing gear hole, fix the landing gear with screw, connect the compass to ribbon wire.
- (3) Install the other landing gear on the left side of the aircraft, and fix the antenna and compass ribbon wire on landing gear via white adhesive plaster separately.



## 5.3 Camera mount and camera (option) Installation

Please choose your needed camera mount and camera.

- Option 1: (1) Fix the camera holding board under the aircraft with screw.  
(2) Install Gopro camera on camera holding board.
- Option 2: (1) Fix the camera mount under aircraft with screw.  
(2) Install camera on camera mount and fix it.

## 6.1 Brushless ESC and Brushless motor Connection

M1/M3 brushless motor is clockwise rotation, please follow the order to connect the wires with yellow, green, red from outside to inside; M2/M4 brushless motor is counterclockwise rotation, please follow the order to connect the wires with green, yellow and red from outside to inside.

## 6.2 Brushless ESC and Power board Connection

Connect the "VCC" to positive pole with red wire, connect "GND" to negative pole with black wire.

Illustration

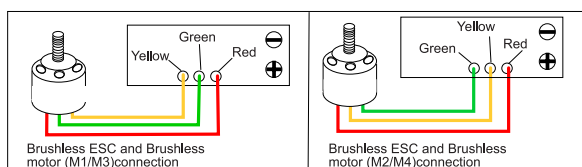

6.1 Brushless ESC and Brushless motor Connection

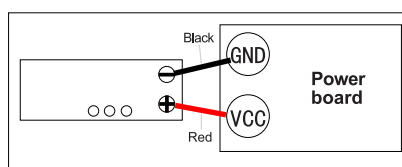

6.2 Brushless ESC and Power board Connection



# 05

## Assembly Instruction



# 06

## Brushless ESC/Brushless motor/Power board connection



# 07

## Main control board guideline

### 7.1 Main control board port Instruction

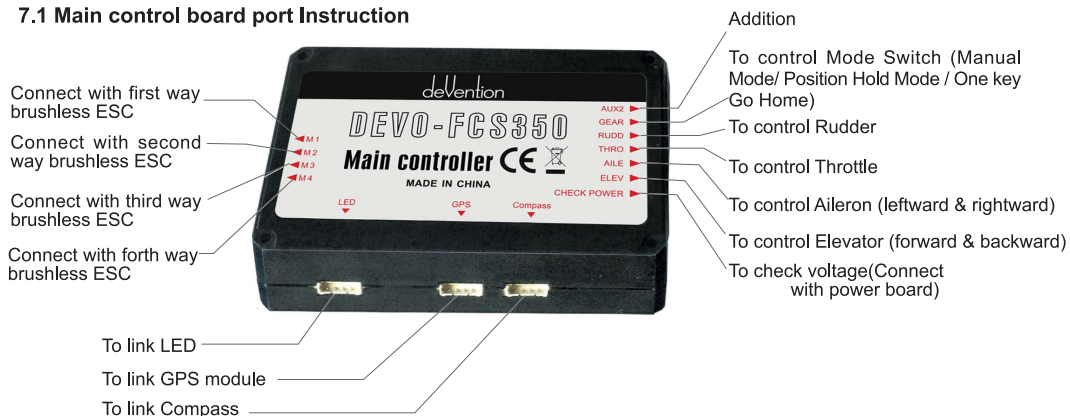

### 7.2 Main control board and Brushless ESC Connection Illustration

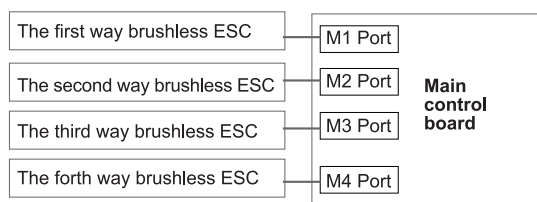

### 7.3 Main control board and Receiver Illustration

Please kindly refer to the manual of transmitter, and set up Elevator, Aileron, Throttle, Rudder, then choose a 3-position switch as Control Switch.

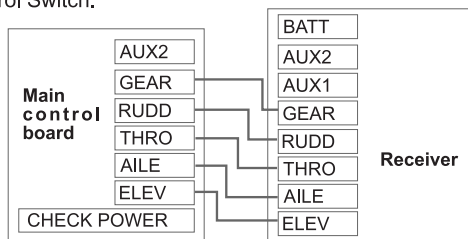

### 7.4 Main Control Board Installation Requirements

- (1) Label side towards the top of the aircraft.
- (2) Side with ESC connector towards forward of the aircraft.
- (3) Keep horizontal with the body of the aircraft.
- (4) Please install the main control board at the CG position and keep all ports are free to connect.

### 8.1 Main Control System Control Mode

#### 8.1.1 Control Mode Classification

There are three control modes according to the 3-position switch: Manual Mode \ Position Hold Mode \ One Key Go Home.

#### 8.1.2 Control Mode Switch Setting (The factory setting is RTF, the default setting use "MIX" switch, please refer 10.1.6 for method).

Please choose a 3-position switch as control mode switch before flight.

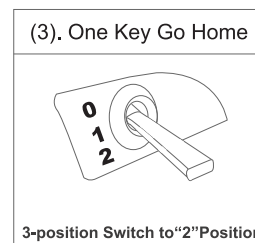
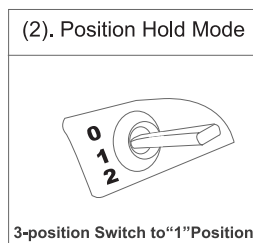
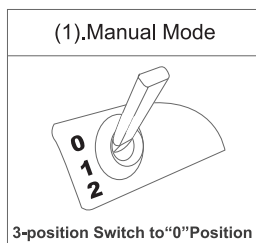

#### 8.1.3 Notes

- (1) Control mode switch position related to channel reverse setting of the transmitter (default setting is normal)
- (2) Please choose manual mode to take off and then turn to position hold and one key return home mode after adjusting the Aircraft attitude by stick or trim and Aircraft at the reasonable height.



# 08

## Basic Flight Instruction



## 8.2 Code binding

Please follow the rule "Turn on transmitter first and aircraft battery later" Turn on the radio first, please connect the aircraft power in 10 second later. The Code binding successfully when the left green LED indicator flash quickly to slowly and then light out last.

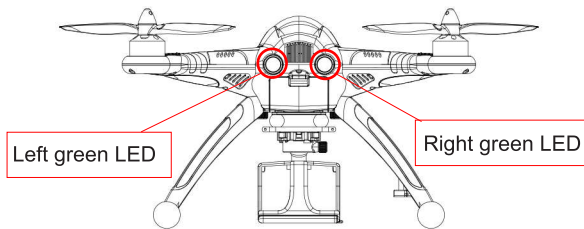

## 8.3 Motor unlock/lock/ Stop rotating

### 8.3.1 Motor unlock

Once binding, down the throttle stick to the lowest position ,move the rudder stick to far LEFT and the left green LED indicator turn solid Green, then motors are unlocking. If you push the throttle up, the motors will rotate (Note:The motor can unlock only when in Manual Mode) .

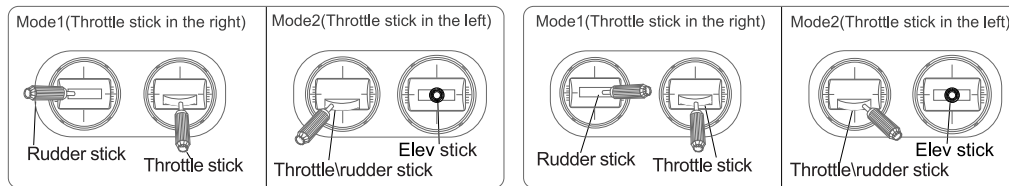

8.3.1 Motor unlock

8.3.2 Motor lock

### 8.3.2 Motor lock

Down the throttle stick to the lowest position, move the rudder stick to far RIGHT, the motors are locked when the left green LED indicator light out. If you push the throttle up, the motors won't rotate.

Notes: The aircraft is in Motor lock status after Code binding successfully.

### 8.3.3 Motors stop rotating

If you push the throttle to the lowest position, the motors stop rotation.

## 8.4 Compass Calibration

**Please calibrate the Compass first in the following condition:**

- (1) the first time for flight.
- (2) when you are in a new environment.
- (3) when you change the original place to a new place.

### 8.4.1 Compass Calibration

- (1) Put aircraft to the horizontal position to lock the motors. ( lock method refer to 8.3.2).
- (2) MODE 1: Push the Throttle stick to the highest point, move the Elevator / Rudder joystick to the bottom left corner, enter into the Calibration Mode.  
MODE 2: Push the Throttle/Rudder stick to the highest point and left side, move the Elevator stick to the bottom, enter into the Calibration Mode.
- (3) Make the aircraft revolves 360 degrees and then keep static and horizontal position 30 seconds, the left Green LED indicator flash quickly to slowly and then light out last, means finished calibration.
- (4) **Please reconnect the aircraft power after calibration.**

#### Illustration

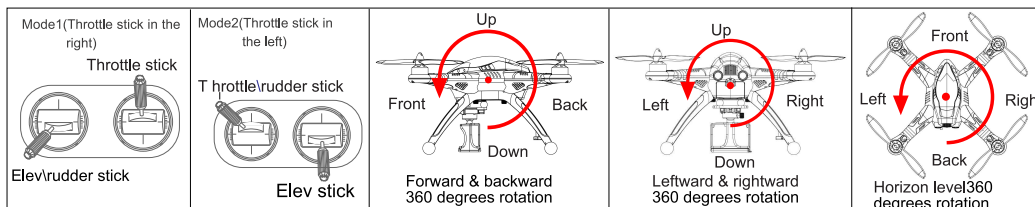

### 8.4.2 Notes:

- (1) Please make calibration keep away from magnetic materials area.
- (2) Please don not carry the magnetic materials when you make calibration.
- (3) Compass does not work properly in the Antarctic Circle and the Arctic Circle.
- (4) Calibrate compass is very important, otherwise, the system cannot work well.
- (5) **Please reconnect the power of the aircraft and recalibrate the Compass if crash.**



## 8.5 Gyro Calibration

The flight control system can do the Gyro Calibration automatically when the aircraft makes the code binding. You can also use the following methods to calibrate.

- (1) Put aircraft to the horizontal position and keep static, lock the motor.
- (2) MODE 1: Push the throttle stick to the lowest point, and move Elevator/Rudder stick to the bottom right corner, enter into calibration mode.  
MODE 2: Push the Throttle/Rudder stick to the lowest point and right side, move the Elevator stick to the bottom, enter into the Calibration Mode.
- (3) Left green LED indicator blinks once and lights off, means finished calibration.

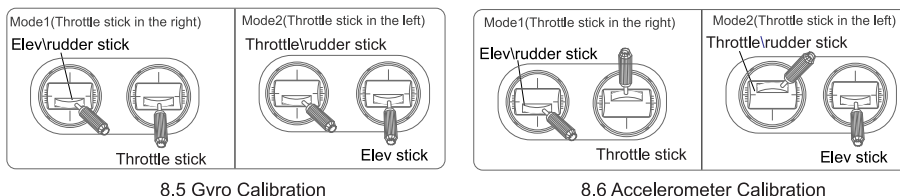

## 8.6 Accelerometer Calibration

The flight control system can do the Accelerometer Calibration automatically when the aircraft makes the code binding. You can also use the following methods to calibrate.

- (1) Put the aircraft to the horizontal position and keep static, lock the motor.
- (2) MODE 1: Push the throttle stick to the highest point, and move the elevator / rudder stick to the bottom right corner, enter into calibration mode.  
MODE 2: Push the Throttle/Rudder stick to the highest point and right side, move the Elevator stick to the bottom, enter into the Calibration Mode.
- (3) Left green LED indicator blinks once and lights off, means finished calibration  
Please re-calibrate Gyro and Accelerometer if the aircraft no gyro response or status is not stable.

## 9.1 The flowchart of GPS Satellites Signal(Need to connect with GPS module)

Notes: The starting position means a point before the departure of the flight control system initialization and automatically check the complete aircraft location.

GPS Satellites	<5	5	6	7	8	9	10	11	12
The right Green LED status	No blinking	Blinking once	Blinking twice	Blinking 3 times	Blinking 4 times	Blinking 5 times	Blinking 6 times	Blinking 7 times	Blinking 8 times

## 9.2 Failsafe to Return & Landing

9.2.1 Here pre-conditions for Failsafe to Return and Landing:

- (1) The Aircraft is in normal flight status and battery voltage is normal.
- (2) GPS function and signal is in good condition ( $\geq 5$  satellites, the right Green LED blinking).

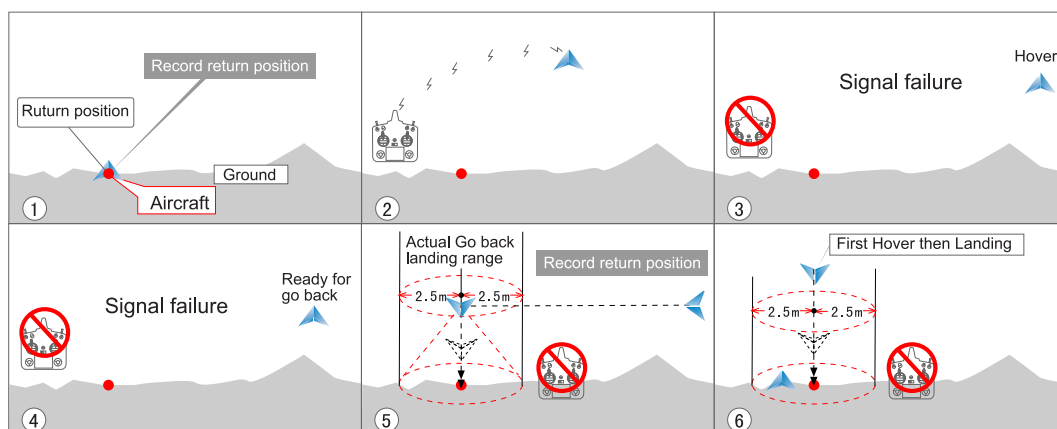

### 9.2.2 Notes:

- (1) To make sure the safe useage,please make sure to record the starting position before departure and know exactly where the starting position is.
- (2) When the aircraft go home, the head is directed at start position, straight flight along the line on the horizon which between the start position and the failsafe point.
- (3) If there are big obstacles around, the aircraft is likely to be blocked on the return trip.
- (4)When GPS signal is bad or GPS is unable to work, the failsafe will not work and the aircraft will not return.

### 9.3 One Key Go Home

Here pre-conditions for One Key Go-Home:

- (1) The Aircraft is in normal flight status and battery voltage is normal.
- (2) GPS function and signal is in good condition ( $\geq 5$  satellites, the right Green LED blinking).

#### 9.3.1 The flowchart of One Key Go-Home

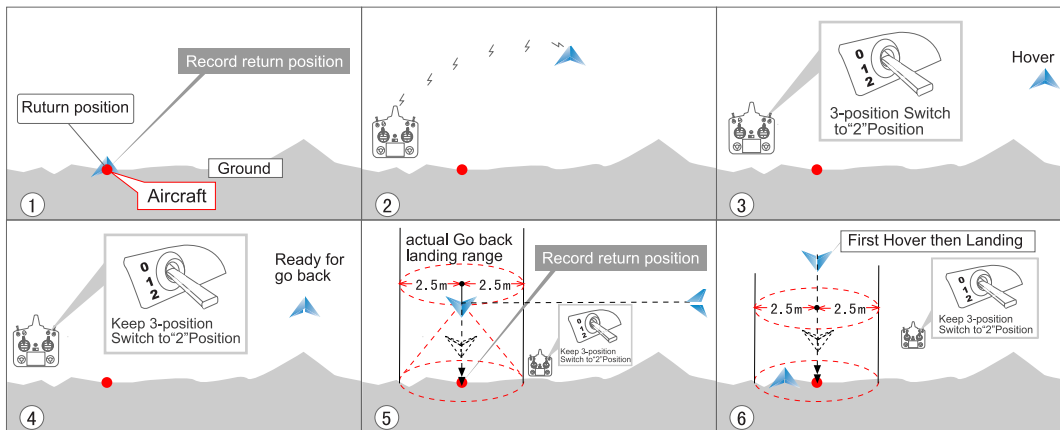

### 9.3.2 Notes:

- (1) Please use manual mode to start to fly, switch to one key go home mode the aircraft begin to return home after landing to the ground and push the throttle stick to the lowest position,the motors would lock automatically,an later need to re-switch to manual mode the motors can unlock.
- (2) To make sure the safe useage,please make sure to record the starting position before departure and know exactly where the starting position is.
- (3) When the aircraft go home, the head is directed at start position, straight flight along the line on the horizon which between the start position and the failsafe point.
- (4) If there are big obstacles around, the aircraft is likely to be blocked on the return trip.
- (5) When GPS signal is bad or GPS is unable to work, the failsafe will not work and the aircraft will not return

### 9.4 Position Hold

Here pre-conditions for Hold Position:

- (1) The Aircraft is in normal flight statusand batteryvoltage is normal.
- (2) GPS function and signal is in good condition ( $\geq 5$  satellites, the right Green LED blinking)

Note:

- (1) In Hold Postion mode,can use transmitter stick to control flight.
- (2) Please use manual mode to start to fly, switch to hold position mode the aircraft will hover stable, after landing to the ground and push the throttle stick to the lowest position,the motor can lock automatically,and later need to re-switch to manual mode the motor can unlock.

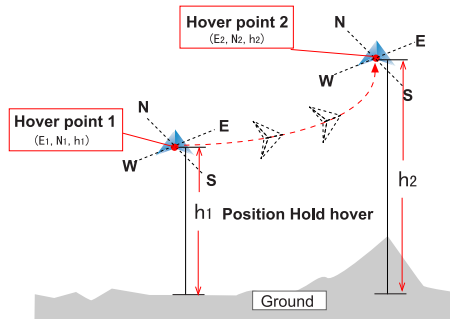

### 9.5 Low Voltage Protection

Low Voltage Protection is a design to avoid the aircraft to crash by the low voltage of the battery.

When the battery voltage is too low, the left green LED will slow blink warning, the aircraft will descent slowly.

Note: When a low voltage alert occurs, please land the aircraft as soon as possible in order to avoid crash.





## 10

### Transmitter control

#### 10.1 DEVO-7(optional radio) setting

##### 10.1.1 Boot Screen

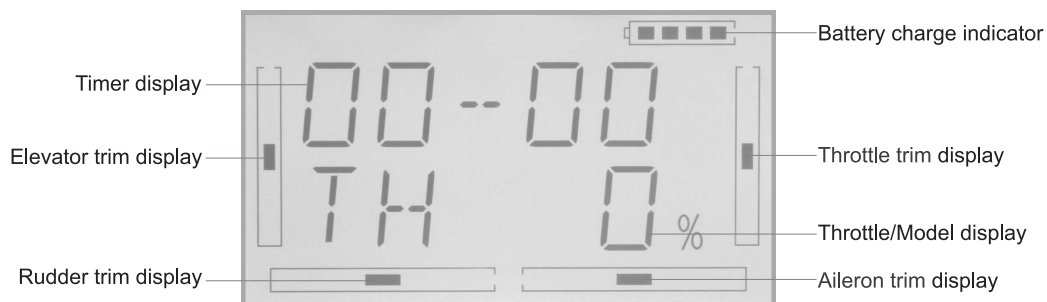

##### 10.1.2 Model Type(TYPE)

Press the ENT button to enter the Main Menu, press UP or DN until MODEL starts to flash, then press ENT button to enter the Model Menu. Press the UP or DN button until TYPE starts to flash. Press the ENT button to choose between Helicopter and Aeroplane types. Press the R or L button to select HELI, press ENT to confirm and EXT to go back to the previous menu.

##### 10.1.3 Model Select(SELEC)

Press UP or DN key under the MODEL menu until SELEC starts to flash. Press ENT, the model options will be shown. Press UP or DN to choose MOD 1, press ENT to confirm and EXT back to previous menu.

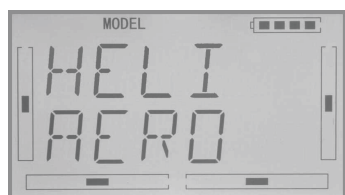

10.1.2 Model Type(TYPE)

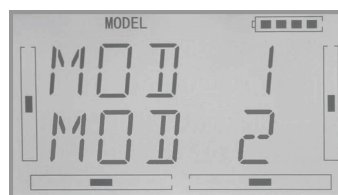

10.1.3 Model Select(SELEC)

##### 10.1.4 Model Name(NAME)

In the MODEL menu, press UP or DN until the NAME starts to flash. Press ENT to access the model serial No. and default name options. Press UP or DN to select the characters or numbers that you wish to change, use the R or L key to change the characters or numbers to "X350". Press ENT to confirm and EXT to go back to the previous menu.

##### 10.1.5 Swash Type(SWASH)

Press the ENT button to enter the MODEL Menu and press UP or DN until SWASH starts to flash and then press ENT key. The Swashplate type will be shown. Press UP or DN to choose 1-NRM and after setting, press ENT to confirm and EXT to go back to the previous menu.

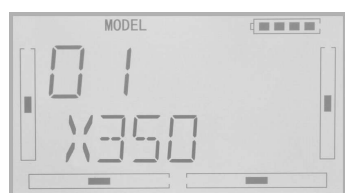

10.1.4 Model Name(NAME)



10.1.5 Swash Type(SWASH)

# QR X350

2.4GHz

## 10.1.6 Device Output(OUTPU)

Press UP or DN under the MODEL menu, it comes out the flashing "OUTPU" menu. Press "ENT" to the submenu of "Output". Press DN or UP to choose "GEAR MIX",and press ENT to confirm. Press DN to choose "GEAR ACT", and press ENT to confirm. Press EXT to exit to the main interface.

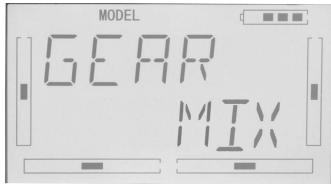

10.1.6 Device Output(OUTPU)



10.1.7 Reverse Switch(REVSW)



## 10.1.7 Reverse Switch(REVSW)

Press ENT to enter the Main Menu, press UP or DN until FUNCTION starts to flash, then press ENT to access the function menu. Press UP or DN until REVSW starts to flash. Press ENT to display the channel name and the reverse status. Press R or L to change between NOR and REV settings. Press DN to display each channel AILE, THRO, RUDD, GEAR, PITCH, AUX2 and their corresponding reverse setting. Set each channel as shown in the table below. Once complete, press ENT to confirm and EXT to go back to the previous menu.

ELEV	AILE	THRO	RUDD	GEAR	PITCH	AUX2
NORM	NORM	NORM	NORM	NORM	NORM	NORM

## 10.2 DEVO-6/F7/8S/10/12S(optional radio)settings

- (1) Type:Helicopter
- (2)Model Name :QR X350
- (3) Swash type:1 Servo Normal
- (4) Device Output

DEVO-6			DEVO-F7			DEVO-8S		
Gear	MIX SW	Active	Gear	MIX SW	Active	Gear	MIX SW	Active
Pitch	System	Active	Pitch	System	Active	Pitch	System	Active
			Aux2	GEAR SW	Active	AUX2	FMOD SW	Active
						AUX3	RUDD D/R	Active

DEVO-10			DEVO-12S		
Gear	MIX SW	Active	Gear	MIX SW	Active
AUX2	FMOD SW	Active	Pitch	System	Active
AUX3	RUDD D/R	Active	AUX2	FMOD SW	Active
AUX4	AUX4 KB	Active	AUX3	AUX3 Lever	Active
AUX5	AUX5 KB	Active	AUX4	AUX4 Lever	Active
			AUX5	AUX5 Lever	Active
			AUX6	AUX6 Knob	Active
			AUX7	AUX7 Knob	Active



# 10

Transmitter control

(5) Reverse switch settings

DEVO-6		DEVO-F7		DEVO-8S	
Elevator	Normal	Elevator	Normal	Elevator	Normal
Aileron	Normal	Aileron	Normal	Aileron	Normal
Throttle	Normal	Throttle	Normal	Throttle	Normal
Rudder	Normal	Rudder	Normal	Rudder	Normal
Gyro	Normal	Gear	Normal	Gear	Normal
Pitch	Normal	Pitch	Normal	Pitch	Normal
		Aux2	Normal	Gyro	Normal
				AUX3	Normal

DEVO-10		DEVO-12S	
Elevator	Normal	Elevator	Normal
Aileron	Normal	Aileron	Normal
Throttle	Normal	Throttle	Normal
Rudder	Normal	Rudder	Normal
Gear	Normal	Gear	Normal
Pitch	Normal	Pitch	Normal
Gyro	Normal	Gyro	Normal
AUX3	Normal	AUX3	Normal
AUX4	Normal	AUX4	Normal
AUX5	Normal	AUX5	Normal
		AUX6	Normal
		AUX7	Normal

11.1 Parameters of GA005 balance charger:

Input voltage	Input current	Output current	Dimension	Weight
DC15-18V	1000mA	≤800mA	62.5×47×20.8mm	46g

11.2 Features of GA005 balance charger

- (1) GA005 utilizes microcomputer chips to monitor and control over the whole charging process in a balanced way with LED indicating light to display the charging status at real time.
- (2) Connects to an input power supply (DC 15-18V 1000 mA).
- (3) GA005 is suitable for 2-3S (7.4V/ 11.1V) Li-ion or Li-polymer battery pack.
- (4) Automatically detects 2-3S Lithium battery pack. GA005 will automatically charge when it finds the voltage of anyone cell among the LiPo pack is excessively low. At the same time LED displays as charging status (flash in red). The voltage of anyone cell LiPo is controlled at the level of  $4.2 \pm 0.05V$  to ensure the maximum voltage difference of single cell in the battery pack is less than 50 mV.



# 11

## Instruction and attention of GA005 balance charger

# QR X350

2.4GHz

## 11.3 Instruction of GA005 balance charger

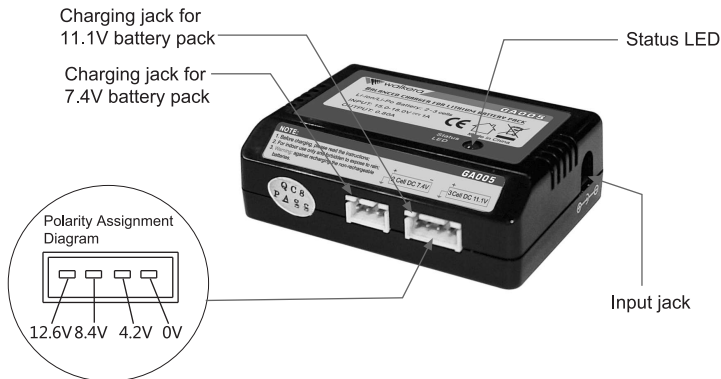

## 11.4 Operation steps



Plug the wall adapter into the mains power supply. Its output end connects to GA005. Then its LED is lighting in solid red.



Insert the balanced pin of LiPo battery pack into GA005.



During charging, Red LED is continuously flashing. If saturated, Red LED becomes solid green lighting.

## 11.5 Charging status corresponding to LED

steps	Operation	LED Status	Charging status
1	Insert the wall adapter into the mains power supply, and then its output is connecting to GA005.	LED is in red solid lighting	Power on
2	Step 1 + connect the battery pack to GA005	LED is flashing in red	Charging
		LED becomes from red to solid green.	Saturated

## 11.6 Matters needing attention

- (1) During charging, GA005 should be put in dry and ventilated place and be far away from heat sources and inflammable and explosive substances.
- (2) GA005 is only used to charging a 2S or 3S Li-ion or Li-polymer battery. It is forbidden to simultaneously charge two or more sets of batteries. Either the charger or battery may be damaged.
- (3) When charging, the battery should be removed from your helicopter. Never leave the charger unsupervised during the process of charging in order to avoid risk of accidents.
- (4) Never immediately charge your battery as soon as the flight is finished, or when its temperature doesn't cool down. Otherwise the battery will take a risk in swelling, even a fire.
- (5) Ensure the correctness of polarity before connecting the battery to charger.
- (6) Avoid drop and violence during the process of charging. Drop and violence will result in internal short circuit of the battery.
- (7) For the sake of safety, please use original charging equipment (wall adapter + GA005 balance charger) and battery. Please change new one in time when the old battery pack is becoming swollen due to long time usage.

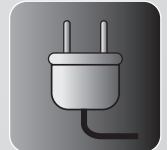

# 11

Instruction  
and  
attention  
of GA005  
balance  
charger

- (8) If it is retained in the charger for a long time after saturated, the battery may automatically discharge. When the charger detects that the voltage of individual cells is lower than the rated voltage, it will re-charge until saturated. Frequently charging and discharging will shorten the lifetime of your battery .



### 11.7 Maintenance of battery pack

- (1) The battery should be put in dry and ventilated place. The storage temperature of the environment is ranged from 18°C to 25°C.
- (2) Please avoid frequent charging and excessive discharging the battery in order to prolong its life cycle.
- (3) It is a must to maintain the battery before long-term storage. That is to charge the battery to the level of 50-60% saturation.
- (4) If the storage term is over 1 month, it is advised to monthly check the voltage of every cell of the battery . The voltage of every cell should be not less than 3V. Otherwise, please refer to the above article (3).
- (5) From the view point of protection, new battery should be motivated before usage. That is to charge and discharge 3-5 times, but discharge is not less than the level of 70% saturation. This process will make the battery lifetime longer and voltage more stable.



## 12

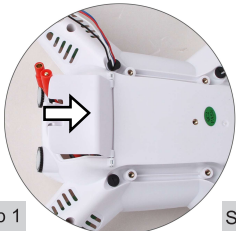

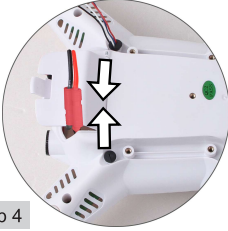
### Steps of flight

 <p>Step 1</p>	 <p>Step 2</p>	 <p>Step 3</p>	 <p>Step 4</p>
<p>Step 1: Open the battery compartment, install the battery pack into the battery compartment along the arrow direction.</p>		<p>Step 2: Turn on the power of transmitter.</p>	
<p>Step 3: Pull down the throttle stick and throttle trim of transmitter to the lowest position, and then move the elevator trim, aileron trim, and rudder trim at the neutral positions, respectively.</p>		<p>Step 4: Connect the power cable of the Aircraft and wait to receive the signal from the transmitter. The Aircraft should be placed on flat ground or surface during code paring (binding). Do not move the transmitter sticks or the Aircraft until binding has completed.</p>	



## 13

### Flight over

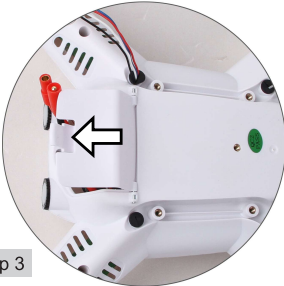
 <p>Step 1</p>	 <p>Step 2</p>	 <p>Step 3</p>
<p>Step 1: disconnect the power cable of Aircraft .</p>	<p>Step 2: turn off the transmitter.</p>	<p>Step 3: take off the battery pack.</p>



# QR X350

2.4GHz

## Mode 1 (throttle stick on the right hand)

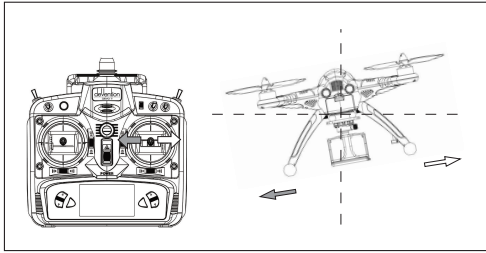

1. When moving the aileron stick left or right, the Aircraft accordingly flies left or right.

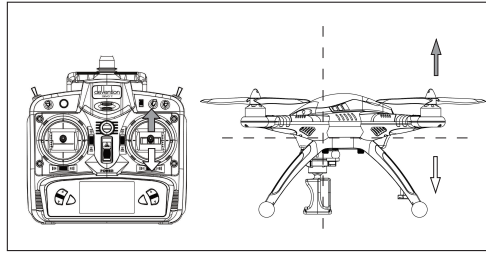

2. When moving the throttle stick up or down, the Aircraft accordingly flies up or down.

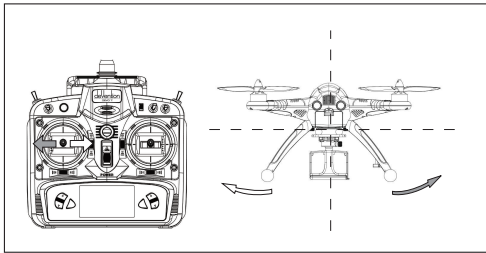

3. When moving the rudder stick left or right, the head of Aircraft accordingly rotates to the left or right.

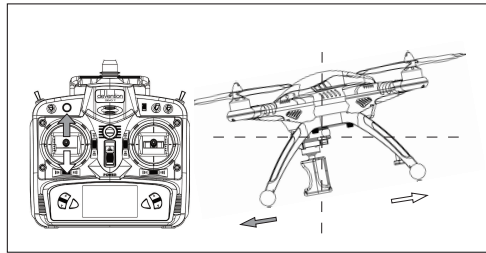

4. When moving the elevator stick up or down, the Aircraft accordingly flies forward or backward.

## Mode 2 (throttle stick on the left hand)

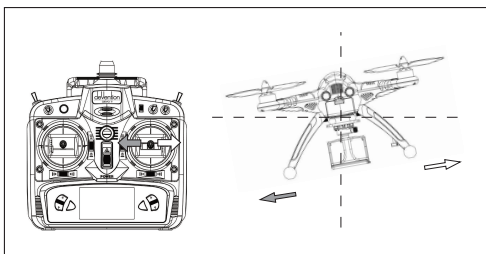

1. When moving the aileron stick left or right, the Aircraft accordingly flies left or right.

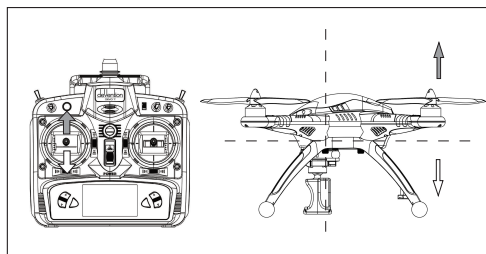

2. When moving the throttle stick up or down, the Aircraft accordingly flies up or down.

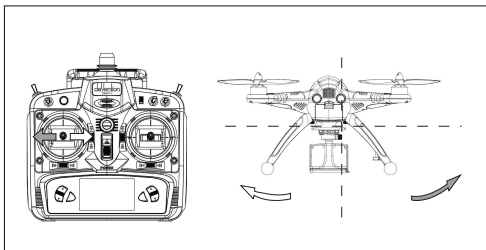

3. When moving the rudder stick left or right, the head of Aircraft accordingly rotates to the left or right.

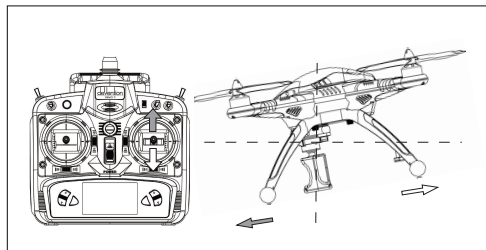

4. When moving elevator stick up or down, the Aircraft according flies forward or backward.



## Appendix 1 – Manual flight control



## Appendix 2 – Trimming the Manual flight actions

### (1) Adjust the rudder trim

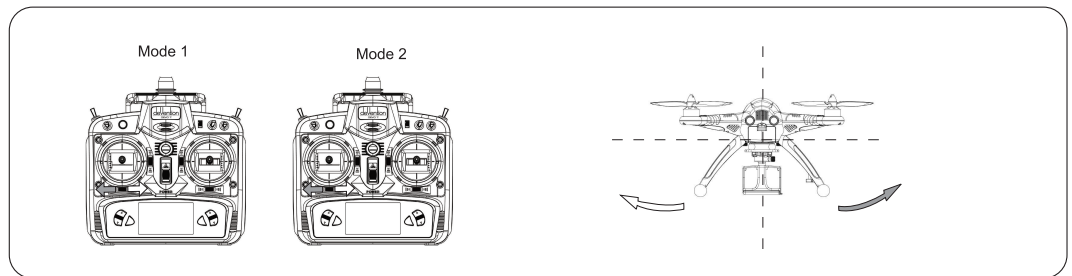

Move the rudder trim right if the head of Aircraft flies leftward during taking off; otherwise move the rudder trim left.

### (2) Adjust the elevator trim

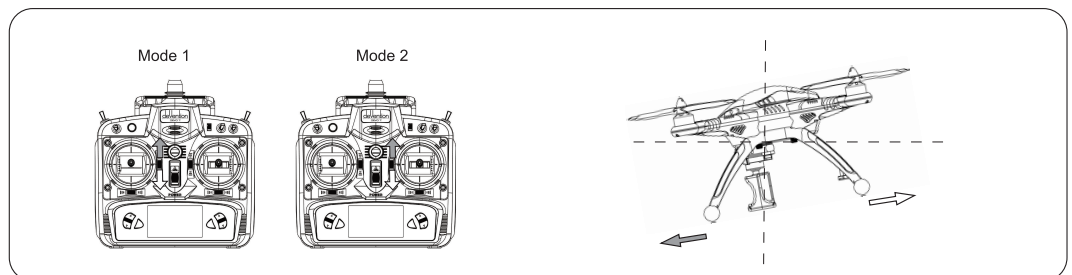

Move the elevator trim down if the Aircraft flies forward during taking off; otherwise move it up.

### (3) Adjust the aileron trim

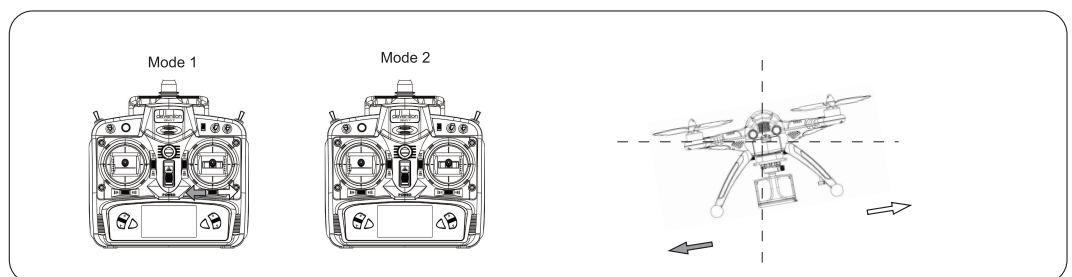

Move the aileron trim right if the Aircraft flies leftward during taking off; otherwise move it left.

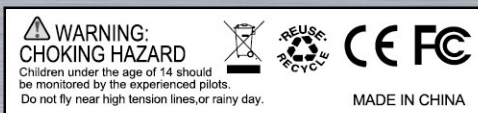

The specifications of the R/C aircraft may  
be altered without notice.



Add.: Taishi Industrial Park, Dongchong Town  
Panyu District, 511475 Guangzhou

Tel.: (8620) 8491 5115 8491 5116

Fax.: (8620) 8491 5117

Web.: [www.walkera.com](http://www.walkera.com)

Email.: [heli@walkera.com](mailto:heli@walkera.com)  
[info@walkera.com](mailto:info@walkera.com)